

# ConSep System

Integrated filtration Chip & Coolant System

Economical / less space / modular

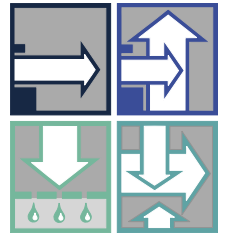

## ConSep2000® II HP The integrated filtration solution

The famous ConSep 2000® System is now improved by integration of a unique indexing filterdrum. The capability of the ConSep 2000® to handle all chips types and various materials has of course remained. Filtration direct at the machine tool is not only space saving, but allows the design of a compact system to achieve optimised coolant cleaning.

The new ConSep 2000® II HP reduces the required preventive maintenance interventions and therefore improves the up-time performance of the coolant system. ConSep 2000® II HP is the ultimate solution for chip handling and integrated coolant cleaning at machining centers, multi-spindle lathes and in particular the high performance integrated lathes.

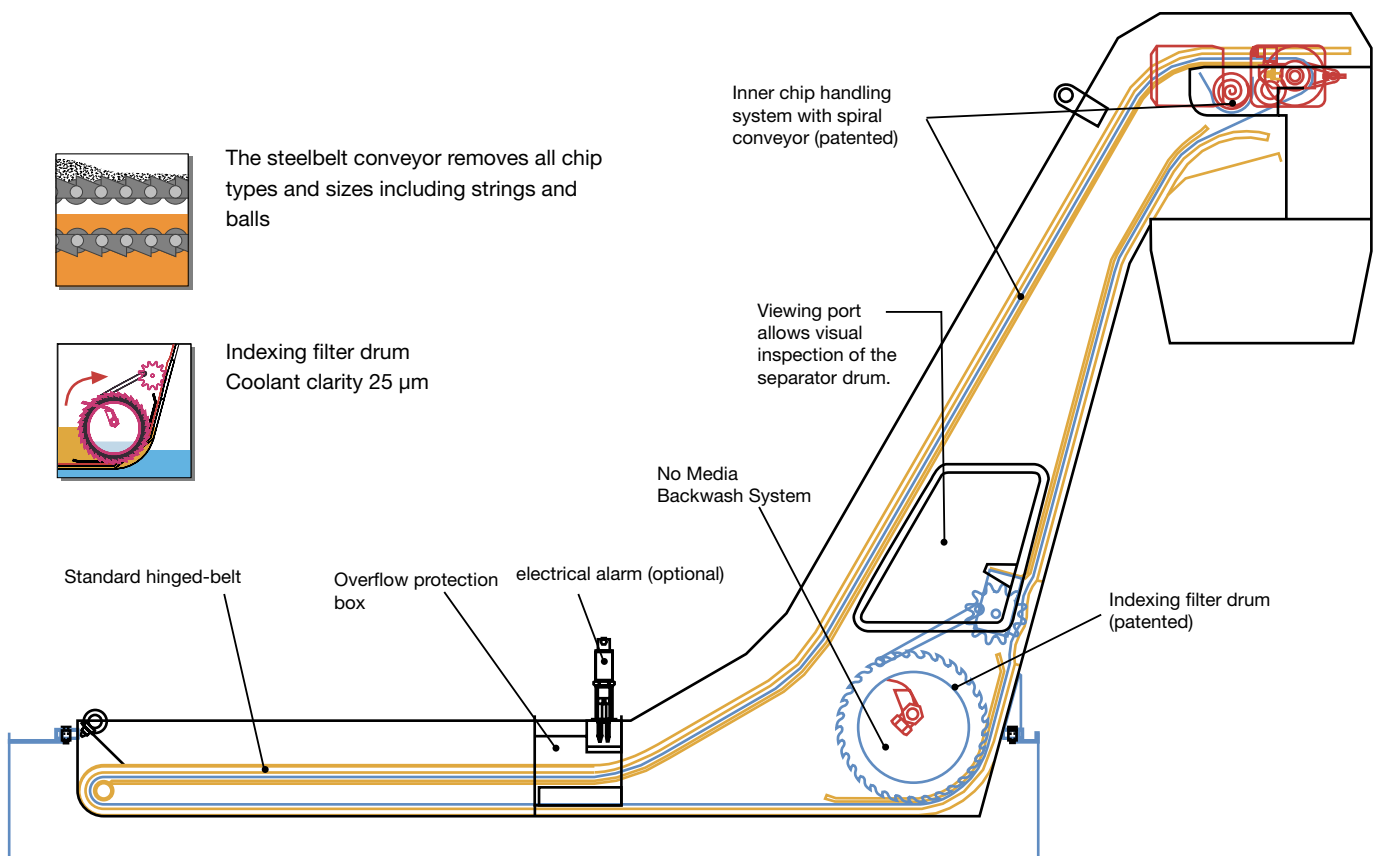

Designed and engineered to worldwide standards

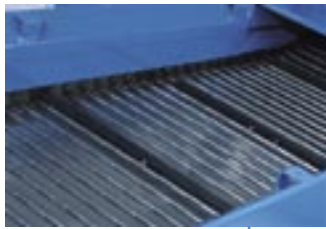
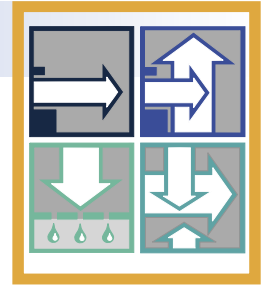

Steel belt conveyor



Auger

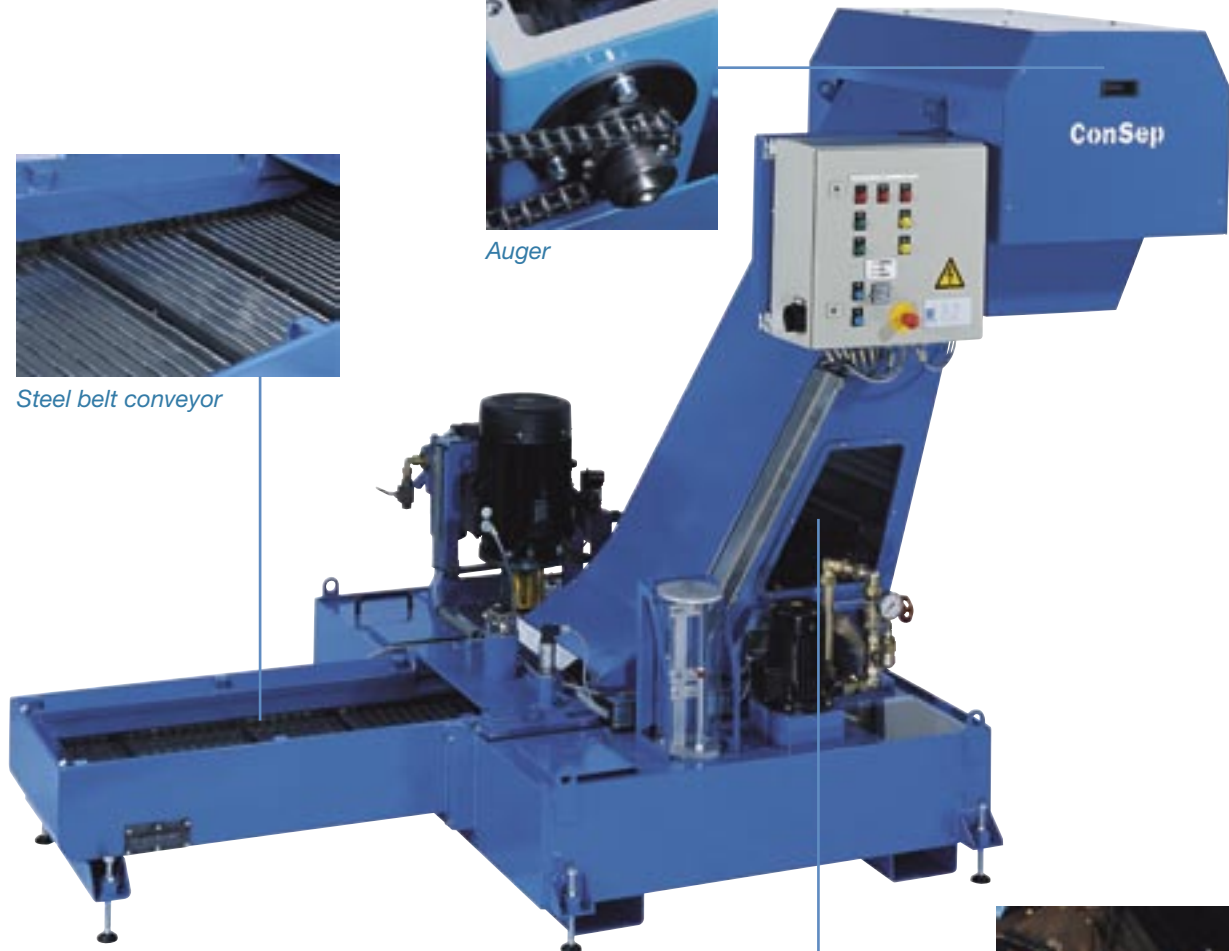

Indexing drum filtration



- Improved coolant cleaning capabilities
- Handling all type of chips and various materials is secured by the steelbelt.
- Protection by the steelbelt prevents damage of the filtration mesh by long, nasty chips and increases the availability of the coolant cleaning system.
- Fines and sediments are handled through a unique inner chip handling system with a spiral conveyor at the discharge.

Modular system design allows ...

**ConSep 2000® II HP** meets your individual coolant  
cleaning requirements now or later



*AT-Cleaner*

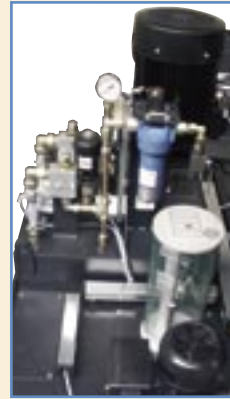

*High-Pressure  
Pump Package*

**High pressure coolant system**

Engineered systems offer 55 l/min,  
20-100 bar (15 GPM @ 300-1500 PSI)

- Variable flow and pressure
- Police filter optional

**Secondary coolant cleaning**

The AT-Cleaner is a hydraulic centrifugal separator requiring no disposable filter media.

- Extends tool life and surface quality
- Minimizes manual cleaning maintenance



*Electrical Controls*

**Plug and run controls**

- Simple integration into existing machine tool controls
- SPS logic control



*Oil skimmer*

**Separation of foreign/tramp oils**

- Skimmer separates floating foreign or tramp oils from the coolant



... for additional coolant cleaning components

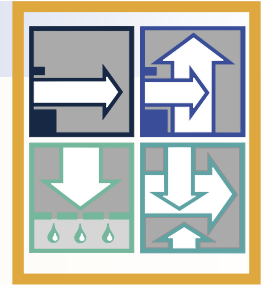

SF2 AT-Cleaner for sludge clean-out

**Minimized sedimentation in tanks**

- Automatically removes sludge and dirt
- Minimal maintenance



Chiller Unit

**For improved machining tolerances**

- Through coolant refrigeration
- Temperature regulating system



Separate coolant tank

**For increased coolant storage volumes**

- Extended coolant filling cycles
- Weekend stand-by mode
- Improved heat dissipation

Integrated clean coolant tank

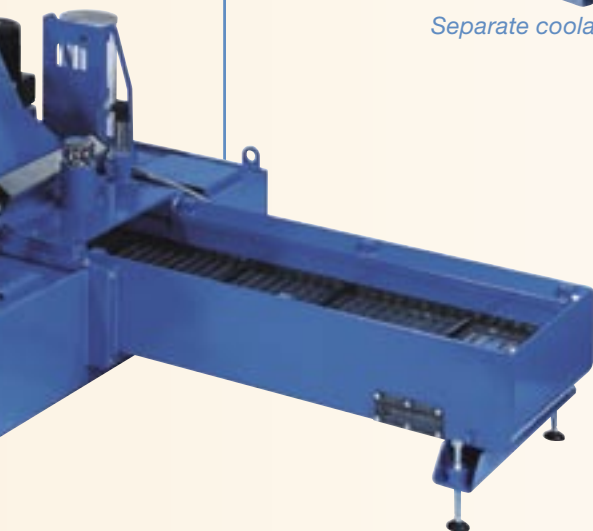

**Wash gun package**

For manual cleaning purposes of machines parts or machine positions, a wash gun can be used. The washgun package is based on an air driven positive displacement pump, requires no electrical controls and consumes minimal space

## Fluid System 2000

### Meet automotive requirements...

- Optimized for 24/7 shift operations
- Highest machine availability
- Minimized space requirements
- modular design
- Lower operation costs
- NO factory floor infrastructure investments
- Extends coolant life



### Basic system components

#### ConSep 2000II Universal chip removal technology & automatic filter system

- Heavy duty steel belt conveyor
- Medium free INDEXING filter drum
- Suitable for all metal chips

#### Pumpback type lift tank with robust coolant lift pump FS 2000 Coolant storage tank (V-shape)

- Mayfran LCD level control device
- Manual (re)-fill connection
- Quick system drain feature for coolant disposal

### Optional components

#### Pump technology for the machine

- High pressure packages up to 120 bars
- Low pressure machine wash packages
- Coolant gun for manual machine/part washing

#### Coolant cleaning Secondary by-pass filtration packages

- for through spindle high pressure circuit only
- for automatic coolant tank cleaning
- for automatic coolant tank cleaning & through spindle high pressure circuit

#### Coolant input control Automatic coolant mixing devices

- 2 phase mixing units
- 3 phase mixing units

#### Coolant conditioning Surface cleaning

- Oil surface skimmer packages
- 2-3 phase sludge centrifuges
- Aeration packages

#### Machining accuracy Coolant refrigeration

- Submerged type refrigerator fixed or ambient temperature control



coolant surface cleaner

# ConSep 2000®

For special applications we use our proven ConSep 2000 System with steelbelt and draglink conveyor

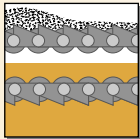
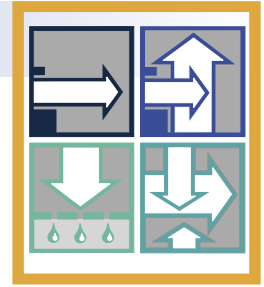

The primary conveyor removes all chip types and sizes including strings and balls

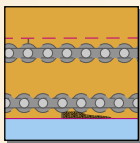

The lower drag-type separator conveyor removes fines that are passed through and carried back into the system by the primary conveyor

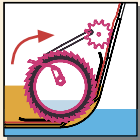

New back wash system separates fines from the coolant to 25 micron nominal

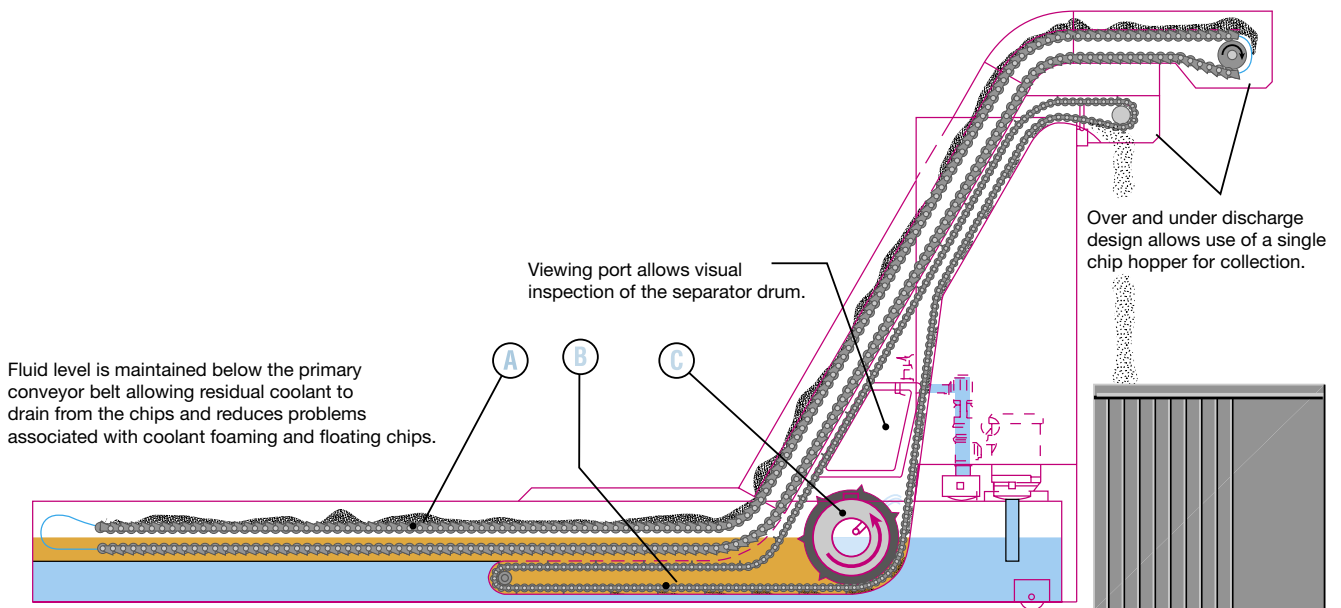
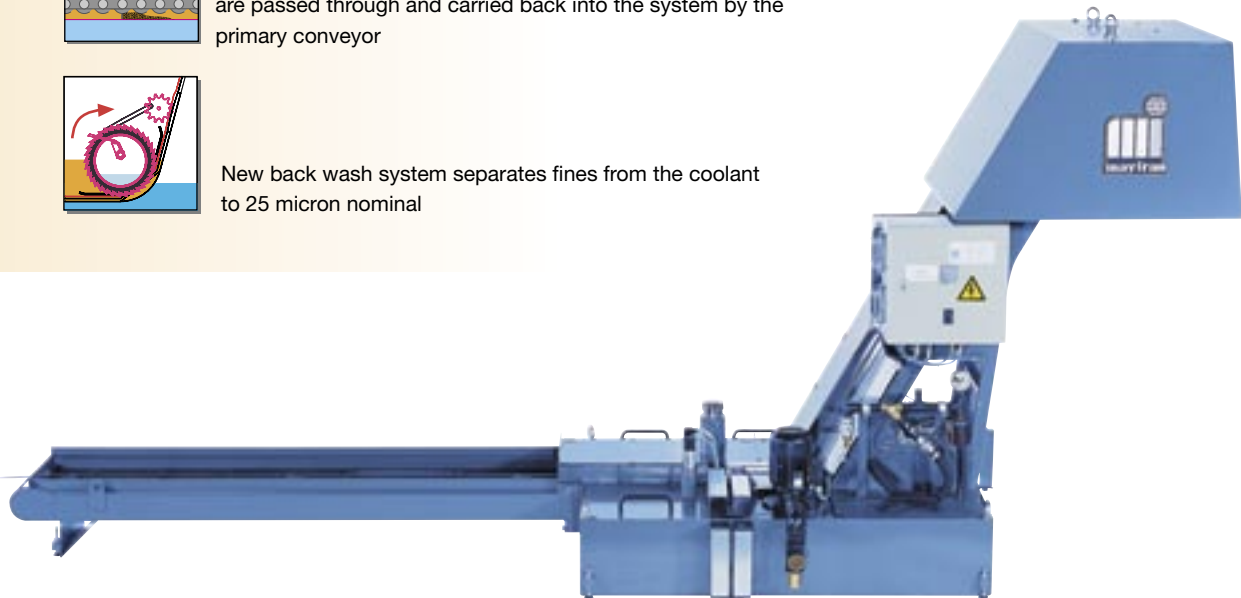



# Serving Global Markets



## **Mayfran International (Inc.)**

P.O. Box 43038  
Cleveland, OH 44143 U.S.A.  
Tel.: +1 44 04 61 41 00  
Fax: +1 44 04 61 55 65  
info@mayfran.com

## **Mayfran International B.V.**

P.B. 31032, Edisonstraat 7  
6370 AA Landgraaf/Niederlande  
Tel.: +31 4 55 32 92 92  
Fax: +31 4 55 32 93 00  
info@mayfran-europe.com  
www.mayfran.co.uk

## **Tsubakimoto Mayfran Inc.**

5001 Ohno, Tsuchiyama-Cho, Kouga-Gun  
Shiga 528-02/Japan  
Tel.: +81 7 48 67 10 01  
Fax: +81 7 48 67 10 97  
www.mayfran.co.jp

## **Korea Mayfran**

72-1, Onsoo-dong  
Kuro-ku 152-120, Seoul/Korea  
Tel.: +82 26 11 58 86  
Fax: +82 26 86 25 21  
www.mayfran.co.kr

## **Miven Mayfran**

P.O. Box 59 Karwar Road,  
Hubli-580 024/Indien  
Tel.: +91 8 36 30 36 77  
Fax: +91 8 36 30 32 65

## **Mayfran GmbH**

Hüttenstraße 7  
D-52068 Aachen/Germany  
Tel.: +49 2 41 93 87 20  
Fax: +49 2 41 17 50 80  
sales@mayfran-europe.com  
www.mayfran.de

## **Niederlassung Süd**

Richthofenstraße 32  
D-73312 Geislingen/Steige  
Tel.: +49 7 33 19 55 30  
Fax: +49 7 33 19 55 355  
sales@mayfran-europe.com

## **Mayfran U.K. Ltd.**

Orchard Court V, Binley Business Park  
Harry Weston Road, Coventry CV3 2TQ/UK  
Tel.: +44 24 76 45 90 00  
Fax: +44 24 76 45 96 90  
www.mayfran.co.uk

## **Mayfran France S.A.R.L.**

Centre D'Affaires, Paris-Nord  
Immeuble le Bonaparte,  
F-93153 Le Blanc Mesnil Cedex/Frankreich  
Tel.: +33 1 48 65 78 00  
Fax: +33 1 48 65 66 55  
www.mayfran.fr

## **Mayfran Canada Ltd.**

5955 Airport Road, Suite 300  
Mississauga, Ontario, Kanada L4V 1R9  
Tel.: +1 90 56 78 00 18  
Fax: +1 90 56 78 00 19